

D2HW



Sealed Subminiature Basic Switch

- Conforms to IP67
- Case dimensions 22% smaller than conventional models
- Extra-long stroke, even without levers. Overtravel: 1.4 mm
- All models are lead-free, including lead wire models
- Post or screw mounting options
- Straight or angled PCB, quick-connect, solder, and lead wire terminal types available
- ROHS Compliant

Part	Rated Resistive Load - Switch	Actuator types	Contact form	Operating Force	Seal type	Termination Style	Service Life - Electrical (Min. @ Rated Loads)
D2HW-A201D	1A @ 24VDC	Pin plunger	SPDT	76g	IP67	Through-Hole PCB - Straight	100,000 ops
D2HW-BL201DL	1A @ 24VDC	Pin plunger	SPDT	76g	IP67	Through-Hole PCB - parallel left	100,000 ops
D2HW-BL201H	1A @ 24VDC	Pin plunger	SPDT	76g	IP67	Solder	100,000 ops
D2HW-BL201M	1A @ 24VDC	Pin plunger	SPDT	76g	IP67	Lead Wires - Bottom exit	100,000 ops
D2HW-BL202M	1A @ 24VDC	Pin plunger	SPST-NC	76g	IP67	Lead Wires - Bottom exit	100,000 ops
D2HW-BL202ML	1A @ 24VDC	Pin plunger	SPST-NC	76g	IP67	Lead Wires - Left Side Exit	100,000 ops
D2HW-BL202MR	1A @ 24VDC	Pin plunger	SPST-NC	76g	IP67	Lead Wires - Right Side Exit	100,000 ops
D2HW-BL203M	1A @ 24VDC	Pin plunger	SPST-NO	76g	IP67	Lead Wires - Bottom exit	100,000 ops
D2HW-BL203ML	1A @ 24VDC	Pin plunger	SPST-NO	76g	IP67	Lead Wires - Left Side Exit	100,000 ops
D2HW-BL203MR	1A @ 24VDC	Pin plunger	SPST-NO	76g	IP67	Lead Wires - Right Side Exit	100,000 ops

BL211DL	24VDC	lever				Hole PCB - parallel left	ops
D2HW-BL211H	1A @ 24VDC	Hinge lever	SPDT	76g	IP67	Solder	100,000 ops
D2HW-BL211M	1A @ 24VDC	Hinge lever	SPDT	76g	IP67	Lead Wires - Bottom exit	100,000 ops
D2HW-BL212M	1A @ 24VDC	Hinge lever	SPST-NC	76g	IP67	Lead Wires - Bottom exit	100,000 ops
D2HW-BL212ML	1A @ 24VDC	Hinge lever	SPST-NC	76g	IP67	Lead Wires - Left Side Exit	100,000 ops
D2HW-BL212MR	1A @ 24VDC	Hinge lever	SPST-NC	76g	IP67	Lead Wires - Right Side Exit	100,000 ops
D2HW-BL213M	1A @ 24VDC	Hinge lever	SPST-NO	76g	IP67	Lead Wires - Bottom exit	100,000 ops
D2HW-BL213ML	1A @ 24VDC	Hinge lever	SPST-NO	76g	IP67	Lead Wires - Left Side Exit	100,000 ops
D2HW-BL213MR	1A @ 24VDC	Hinge lever	SPST-NO	76g	IP67	Lead Wires - Right Side Exit	100,000 ops
D2HW-BR211DR	1A @ 24VDC	Hinge lever	SPDT	76g	IP67	Through-Hole PCB - parallel right	100,000 ops
D2HW-BR211H	1A @ 24VDC	Hinge lever	SPDT	76g	IP67	Solder	100,000 ops
D2HW-BR211M	1A @ 24VDC	Hinge lever	SPDT	76g	IP67	Lead Wires - Bottom exit	100,000 ops
D2HW-BR212M	1A @ 24VDC	Hinge lever	SPST-NC	76g	IP67	Lead Wires - Bottom exit	100,000 ops
D2HW-BR212ML	1A @ 24VDC	Hinge lever	SPST-NC	76g	IP67	Lead Wires - Left Side Exit	100,000 ops
D2HW-BR212MR	1A @ 24VDC	Hinge lever	SPST-NC	76g	IP67	Lead Wires - Right Side Exit	100,000 ops
D2HW-BR213M	1A @ 24VDC	Hinge lever	SPST-NO	76g	IP67	Lead Wires - Bottom exit	100,000 ops
D2HW-BR213ML	1A @ 24VDC	Hinge lever	SPST-NO	76g	IP67	Lead Wires - Left Side Exit	100,000 ops
D2HW-BR213MR	1A @ 24VDC	Hinge lever	SPST-NO	76g	IP67	Lead Wires - Right Side Exit	100,000 ops

Sealed Subminiature Snap Action Switch D2HW







Smallest Sealed Snap-Action Switch in the Industry With a Long Stroke For Reliable ON/OFF Action

- Conforms to IP67 (lead wire type) and IP50 (terminal type)
- Case dimensions 22% smaller than conventional models
- Extra-long stroke even without levers (OT: 1.4 mm)
- All models are lead-free, including lead wire models
- RoHS Compliant







Ordering Information

■ PCB-MOUNTED MODELS









Actuator	Terminals		Contact form	Model		
				With posts on right 	With posts on left 	Without posts 
Pin plunger 	For PCB	Straight	SPDT	---	---	D2HW-A201D
				D2HW-BR201DR	D2HW-BL201DL	---
Hinge lever 		Straight		---	---	D2HW-A211D
				D2HW-BR211DR	D2HW-BL211DL	---
Long hinge lever 		Straight		---	---	D2HW-A221D
				D2HW-BR221DR	D2HW-BL221DL	---
Simulated roller lever 		Straight		---	---	D2HW-A231D
				D2HW-BR231DR	D2HW-BL231DL	---

■ MODELS WITH SOLDER TERMINALS OR LEAD WIRE TERMINALS

Actuator	Terminals		Contact form	Model		
				With posts on right 	With posts on left 	M3-screw mounting 
Pin plunger 	Solder	Downwards	SPDT	D2HW-BR201H	D2HW-BL201H	D2HW-C201H
			SPDT	D2HW-BR201M	D2HW-BL201M	D2HW-C201M
	Lead wire		SPST-NC	D2HW-BR202M	D2HW-BL202M	D2HW-C202M
			SPST-NO	D2HW-BR203M	D2HW-BL203M	D2HW-C203M





(This table continues on the next page.)

Ordering Information - continued from previous page

Actuator	Terminals		Contact form	Model		
				With posts on right 	With posts on left 	M3-screw mounting 
Pin plunger 	Lead wire	Right-side	SPST-NC	D2HW-BR202MR	D2HW-BL202MR	D2HW-C202MR
			SPST-NO	D2HW-BR203MR	D2HW-BL203MR	D2HW-C203MR
		Left-side	SPST-NC	D2HW-BR202ML	D2HW-BL202ML	---
			SPST-NO	D2HW-BR203ML	D2HW-BL203ML	---
Hinge lever 	Solder		SPDT	D2HW-BR211H	D2HW-BL211H	D2HW-C211H
	Lead wire	Downwards	SPDT	D2HW-BR211M	D2HW-BL211M	D2HW-C211M
			SPST-NC	D2HW-BR212M	D2HW-BL212M	D2HW-C212M
			SPST-NO	D2HW-BR213M	D2HW-BL213M	D2HW-C213M
		Right-side	SPST-NC	D2HW-BR212MR	D2HW-BL212MR	D2HW-C212MR
			SPST-NO	D2HW-BR213MR	D2HW-BL213MR	D2HW-C213MR
		Left-side	SPST-NC	D2HW-BR212ML	D2HW-BL212ML	---
	SPST-NO		D2HW-BR213ML	D2HW-BL213ML	---	
Long hinge lever 	Solder		SPDT	D2HW-BR221H	D2HW-BL221H	D2HW-C221H
	Lead wire	Downwards	SPDT	D2HW-BR221M	D2HW-BL221M	D2HW-C221M
			SPST-NC	D2HW-BR222M	D2HW-BL222M	D2HW-C222M
			SPST-NO	D2HW-BR223M	D2HW-BL223M	D2HW-C223M
		Right-side	SPST-NC	D2HW-BR222MR	D2HW-BL222MR	D2HW-C222MR
			SPST-NO	D2HW-BR223MR	D2HW-BL223MR	D2HW-C223MR
		Left-side	SPST-NC	D2HW-BR222ML	D2HW-BL222ML	---
	SPST-NO		D2HW-BR223ML	D2HW-BL223ML	---	
Simulated roller lever 	Solder		SPDT	D2HW-BR231H	D2HW-BL231H	D2HW-C231H
	Lead wire	Downwards	SPDT	D2HW-BR231M	D2HW-BL231M	D2HW-C231M
			SPST-NC	D2HW-BR232M	D2HW-BL232M	D2HW-C232M
			SPST-NO	D2HW-BR233M	D2HW-BL233M	D2HW-C233M
		Right-side	SPST-NC	D2HW-BR232MR	D2HW-BL232MR	D2HW-C232MR
			SPST-NO	D2HW-BR233MR	D2HW-BL233MR	D2HW-C233MR
		Left-side	SPST-NC	D2HW-BR232ML	D2HW-BL232ML	---
	SPST-NO		D2HW-BR233ML	D2HW-BL233ML	---	
Leaf lever 	Solder		SPDT	D2HW-BR261H	D2HW-BL261H	D2HW-C261H
	Lead wire	Downwards	SPDT	D2HW-BR261M	D2HW-BL261M	D2HW-C261M
			SPST-NC	D2HW-BR262M	D2HW-BL262M	D2HW-C262M
			SPST-NO	D2HW-BR263M	D2HW-BL263M	D2HW-C263M
		Right-side	SPST-NC	D2HW-BR262MR	D2HW-BL262MR	D2HW-C262MR
			SPST-NO	D2HW-BR263MR	D2HW-BL263MR	D2HW-C263MR
		Left-side	SPST-NC	D2HW-BR262ML	D2HW-BL262ML	---
	SPST-NO		D2HW-BR263ML	D2HW-BL263ML	---	
Simulated leaf lever 	Solder		SPDT	D2HW-BR271H	D2HW-BL271H	D2HW-C271H
	Lead wire	Downwards	SPDT	D2HW-BR271M	D2HW-BL271M	D2HW-C271M
			SPST-NC	D2HW-BR272M	D2HW-BL272M	D2HW-C272M
			SPST-NO	D2HW-BR273M	D2HW-BL273M	D2HW-C273M
		Right-side	SPST-NC	D2HW-BR272MR	D2HW-BL272MR	D2HW-C272MR
			SPST-NO	D2HW-BR273MR	D2HW-BL273MR	D2HW-C273MR
		Left-side	SPST-NC	D2HW-BR272ML	D2HW-BL272ML	---
	SPST-NO		D2HW-BR273ML	D2HW-BL273ML	---	

(This table continues on the next page.)

Ordering Information - continued from previous page

Actuator	Terminals		Contact form	Model		
				With posts on right 	With posts on left 	M3-screw mounting 
Long leaf lever 	Lead wire	Downwards	SPDT	D2HW-BR281M	D2HW-BL281M	D2HW-C281M
			SPST-NC	D2HW-BR282M	D2HW-BL282M	D2HW-C282M
			SPST-NO	D2HW-BR283M	D2HW-BL283M	D2HW-C283M
		Right-side	SPST-NC	---	---	D2HW-C282MR
			SPST-NO	---	---	D2HW-C283MR

Note: 1. The length of standard lead wires (AWG20) for lead wire models is 30 cm (12 in).

Note: 2. Optional post length (1.5 mm on left or right) also available. Contact your Omron representative for more information.

Specifications

CHARACTERISTICS

Item	Specification
Operating speed	1 mm to 500 mm/s (for pin plunger models)
Operating frequency	30 operations/min
Insulation resistance	100 MΩ min. (at 500 VDC)
Contact resistance (initial value)	100 mΩ max. (lead wire models: 150 mΩ max.)
Dielectric strength	600 VAC, 50/60 Hz for 1 min between terminals of the same polarity 1,500 VAC, 50/60 Hz for 1 min between current-carrying metal parts and ground, and between each terminal and non-current-carrying metal parts
Vibration resistance	Malfunction: 10 to 55 Hz, 1.5-mm double amplitude
Shock resistance	Malfunction: 300 m/s ² max.
Life expectancy	Mechanical: 1,000,000 operations min. (30 operations/min) Electrical: 100,000 operations min. (20 operations/min)
Degree of protection	IP67 for lead wire type, IP50 for terminal type
Degree of protection against electric shock	Class I
Proof tracking index (PTI)	175
Switch category	A (IEC 335)
Ambient operating temperature	-40 to 85°C (with no icing)
Ambient operating humidity	95% max. (in temperature range 5° to 35°C)
Weight	Approx. 0.7 g (for pin plunger models with terminals)

OPERATING CHARACTERISTICS

Part number	D2HW-□20□□		D2HW-□21□□		D2HW-□22□□	
	Models without posts	Models with posts and M3-mounting models	Models without posts	Models with posts and M3-mounting models	Models without posts	Models with posts and M3-mounting models
OF max.	76 gf		76 gf		50 g	
RF min.	10 gf		7 gf		3 gf	
MD max.	0.25 mm		0.5 mm		0.8 mm	
OT ref.	1.4 mm		1.6 mm		2.5 mm	
FP max.	11.2 mm	7.2 mm	12.8 mm	8.8 mm	15.5 mm	11.5 mm
OP	10.4±0.2 mm	6.4±0.2 mm	11.5±0.5 mm	7.5±0.5 mm	13.3±0.8 mm	9.3±0.8 mm
TTP max.	9.1 mm	5.1 mm	10 mm	6 mm	11 mm	7 mm

Operating Characteristics - continued from previous page

Part number	D2HW-□23□□		D2HW-□26□□	D2HW-□27□□	D2HW-□28□□
Characteristic	Models without posts	Models with posts and M3-mounting models	Models with posts and M3-mounting models	Models with posts and M3-mounting models	Models with posts and M3-mounting models
OF max.	66 gf		183 gf	183 gf	92 gf
RF min.	5 gf		20 gf	20 gf	5 gf
MD max.	0.5 mm		0.2 mm	0.5 mm	0.7 mm
OT ref.	1.9 mm		1.8 mm	2.0 mm	2.8 mm
FP max.	16.5 mm	12.5 mm	9.3 mm	12.5 mm	19 mm
OP	15.2±0.5 mm	11.2±0.5 mm	7.4±0.5 mm	10.8±0.5 mm	15.4±1.5 mm
TTP max.	13.5 mm	9.5 mm	5.8 mm	8.9 mm	12.8 mm

■ RATINGS

Rated voltage (V)	Resistive load
12 VDC	2 A
24 VDC	1 A
42 VDC	0.5 A

Minimum applicable load (see note)	1 mA at 5 VDC
------------------------------------	---------------

Note: Minimum applicable loads are indicated by N standard reference values. This value represents the failure rate at a 60% (λ_{60}) reliability level (JIS C5003). The equation $\lambda_{60}=0.5 \times 10^{-6}/\text{operations}$ indicates that a failure rate of 1/2,000,000 operations can be expected at a reliability level of 60%.

■ CONTACT FORM

SPDT Contacts

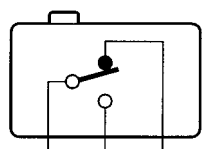

COM (Black) NO (Blue) NC (Red)

SPST-NC Contacts (Lead Wire Models)

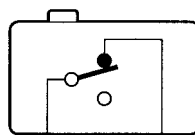

COM (Black) NC (Red)

SPST-NO Contacts (Lead Wire Models)

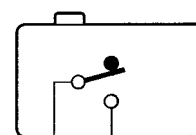

COM (Black) NO (Blue)

Note: Lead wire colors are indicated in parentheses.

Dimensions

Unit: mm (inch)

■ PIN PLUNGER

D2HW-□20□□

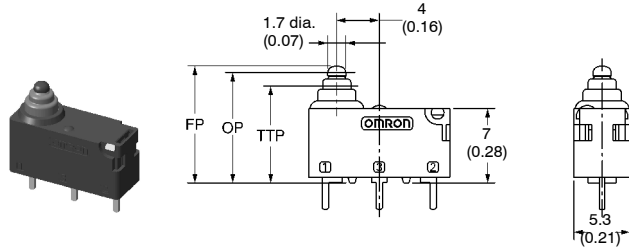

■ HINGE LEVER

D2HW-□21□□

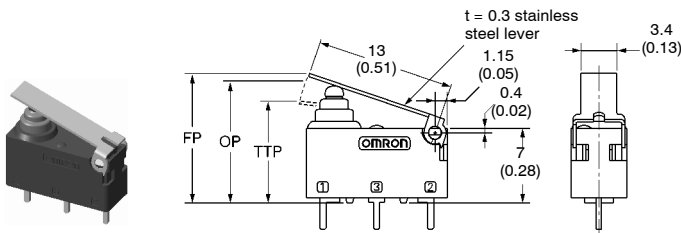

■ LONG HINGE LEVER

D2HW-□22□□

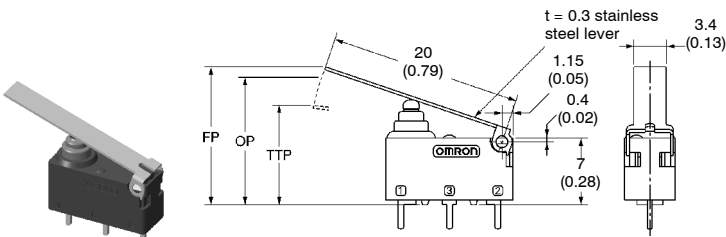

■ SIMULATED ROLLER LEVER

D2HW-□23□□

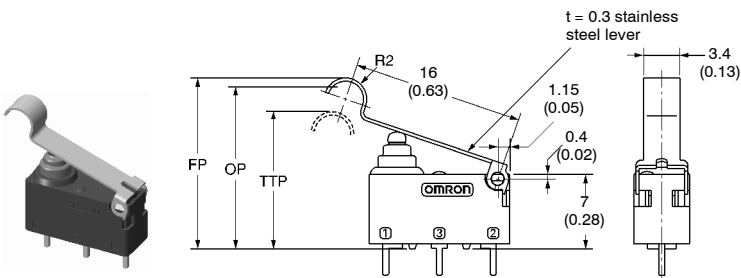

Unit: mm (inch)

■ LEAF LEVER

D2HW-□26□□

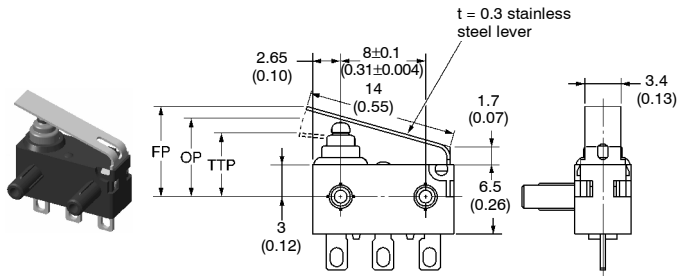

■ SIMULATED LEAF LEVER

D2HW-□27□□

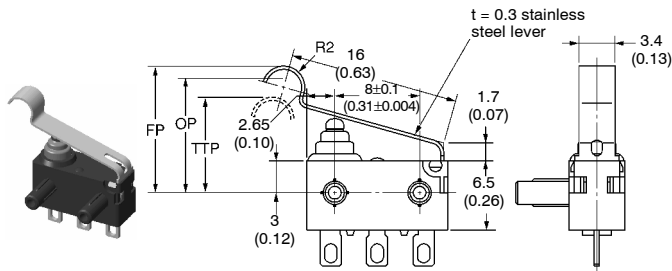

■ LONG LEAF LEVER

D2HW-□28□□

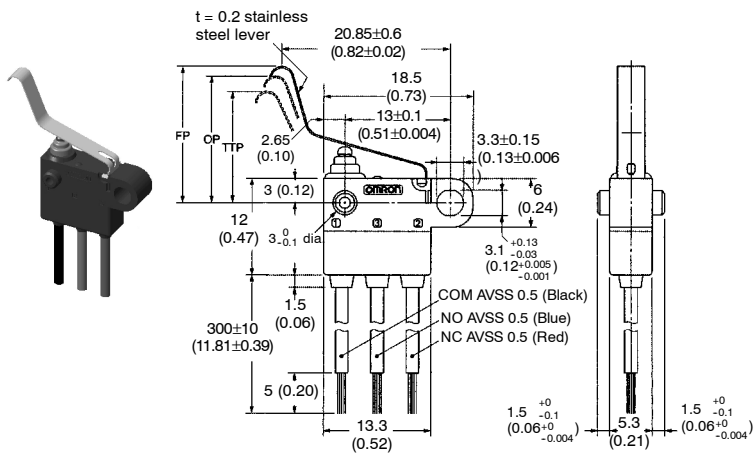

Note: Dimensions not indicated in the above diagrams have a tolerance of ± 0.2 mm.

■ MOUNTING STRUCTURE AND REFERENCE POSITIONS

The reference positions used for FP, OP, and TTP values are as shown below for each type of mounting.

D2HW-A □ Models without Posts

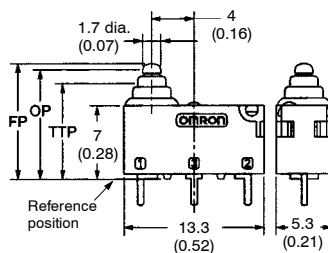

D2HW-B □ Models with Posts

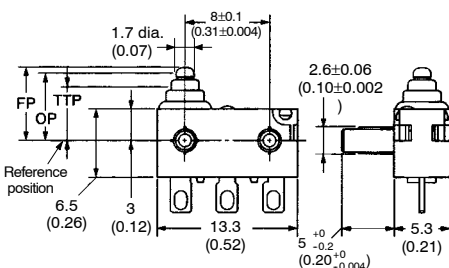

D2HW-C □ M3-screw Mounting Models

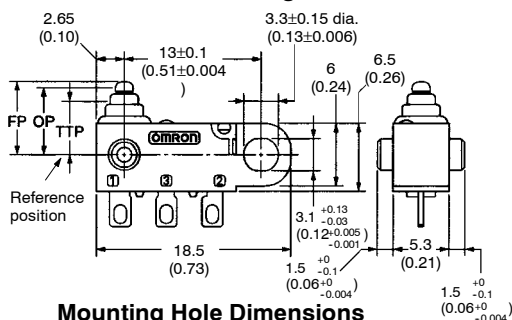

Mounting Hole Dimensions (Reference)

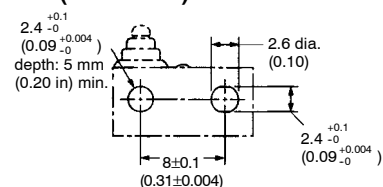

Mounting Hole Dimensions (Reference)

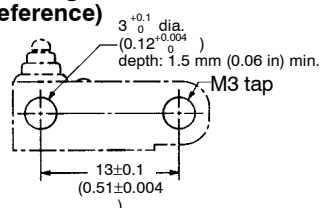

■ TERMINALS

Straight PCB Terminals

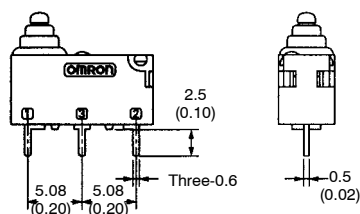

PCB Cutout Dimensions (Reference)

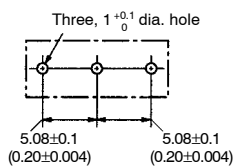

Angled PCB Terminals

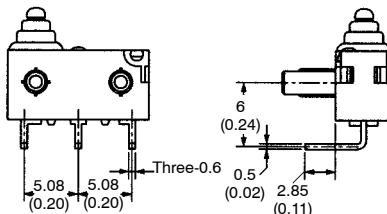

PCB Cutout Dimensions (Reference)

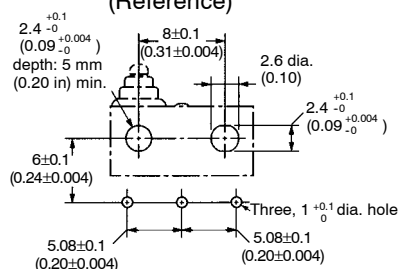

Solder Terminals

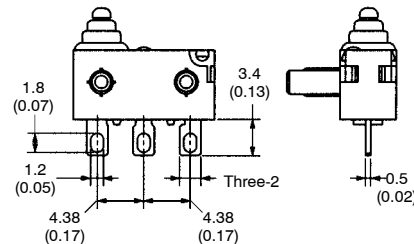

Lead Wires Downwards

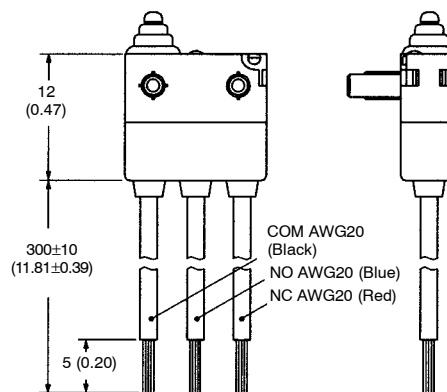

Lead Wires on Left-side

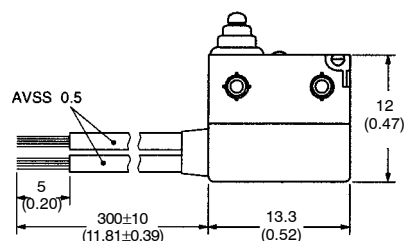

Lead Wires on Right-side

